

Benjamin Sheridan Corporation



Benjamin SUPER SINGLE SHOT AIR PISTOLS

The WORLD'S FAVORITE! Time Tested and Proven. Most **ECONOMICAL** and **SAFEST AIR PISTOLS** on the Market. **LIGHT-WEIGHT - ACCURATE - CONVENIENT - PRACTICAL** - shoot **INDOORS** or **OUTDOORS** for Target, Plinking and Small Game Hunting. **ADJUSTABLE FIRING FORCE** depends on Air

Pressure according to number of Pump Strokes with **AMAZING PEAK POWER**. An Expertly Engineered, Precision-Made Handgun that will appeal to those who Want and Expect **MAXIMUM PERFORMANCE** and **DEPENDABILITY**. Sample Supply of Ammo included with each Model.

SPECIFICATIONS: Models No. 130, 132 and 137 - Gun Metal Finish Bronze Barrels. Plastic Checkered Grips simulated walnut Wood Grain with Thumb Rests. Positive Push-Type, Cross-Lock Safety. Rear Sight Adjustable for Elevation and Windage. Front Blade Sight. Available Caliber BB or .177 or .22. **ACCURACY:** No. 130 Groups under 1-1/4" at 25'; No. 132 Groups under 3/4" at 25'; No. 137 Groups under 3/4" at 25'. Penetration to 3/8" in Soft Pine. Trigger Pull 2 to 3 lbs., Wt. 2 lbs. Overall Length 11". Barrel Length 8". Muzzle Velocity approximately 500 F/P/S. No Forward Lunge or Recoil - No Fouling or Cleaning.

No. 130 Cal. BB-
Smooth Bore 

No. 132 Cal. .22-
Rifled 

No. 137 Cal. .177-
Rifled 

(Cal. .177 PELLETS may be used in this Model for more accurate shooting.)

Benjamin Sheridan

Corporation

KEEP FOR FUTURE REFERENCE — INSTRUCTION SHEET FOR NO. 130—132—137 BENJAMIN SUPER SINGLE SHOT AIR PISTOLS

THIS GUN HAS BEEN CAREFULLY TESTED for compression and accuracy by shooting it several times before passing our inspection. The operation of same is under your control and it will give satisfactory results if instructions are followed.

KNOW YOUR GUN. It is important that you understand how gun operates to obtain satisfactory performance. Use gun often as frequent operation keeps Piston and Valves flexible.

SOMETIMES VALVES LEAK on first pump, but usually seat themselves after pressure is raised in Air Chamber unless Valves are worn or unyielding. If there is no pressure in Air Chamber when you start pumping try cocking the Hammer which will take pressure off of Outlet Valve. You should keep a light charge of air in gun when not in use.

THERE CANNOT BE ANYTHING SERIOUSLY WRONG with a new gun. Any failure is due to damage in shipment or one of the following reasons: SAFETY IS ON; gun has been pumped up too much; Shot Barrel is jammed; Valve is unseated; examine Pump Piston; check Trigger.



TO PUMP PISTON hold it in left hand and pull Pump Lever out until Pump Piston passes air intake hole, then push Pump Lever back against pump barrel. Pump 5 or 6 strokes for ordinary use; 10 or 12 strokes will give maximum force. It is necessary to pump this model up after each shot.

SHOOTING FORCE IS ADJUSTABLE. You can determine number of pumps needed for various uses after a little practice; 3 or 4 pumps are required for shooting pellet out.

IF GUN IS HARD TO PUMP you may be pumping against a full Air Chamber or Pump Cylinder is dry.

LUBRICATE PUMP CYLINDER if Pump Piston binds; keep Felt Washer oiled; spray a little fine graphite or light machine oil in air hole of Pump Barrel. Do not lubricate Pump Cylinder excessively as oil may be forced into Air Chamber when pumping; this may damage valve packing.

DO NOT PUMP THESE GUNS UP TOO MUCH as excessive internal pressure will not permit Outlet Valve to open up wide when firing. owing to air pressure being greater than blow of Hammer, which reduces shooting force; excessive strain will bend or buckle Pump Lever. Both Valves are often damaged when gun is overpumped and must be replaced even in new guns. To reduce Excessive Internal Pressure continue to fire blank as often as it is necessary until Air Chamber is empty.

AFTER AIR PISTON IS PUMPED UP, turn No. 145 Button on Bolt to left until pin clears Breech Cap and pull Bolt all the way back until No. 103 Trigger engages No. 192 Hammer, when you will hear a click.

No. 130 BENJAMIN AIR PISTON SHOOT'S LEAD OR STEEL AIR RIFLE SHOT. After Bolt is pulled back PRESS ROUND AIR RIFLE SHOT IN THE END OF BOLT which is bored out for this purpose, with index finger (not in hole in side of Bolt which is for another purpose); push Bolt forward and lock it by turning Button to right, which seals Breech end of Shot Barrel and prevents air from escaping at this point when gun is fired; also advances Shot to firing position; ROUND SHOT WILL NOT ROLL OUT when aiming below level if end of Bolt is not damaged. We do not make Lead or Steel Air Rifle (88) Shot; we handle the best quality available. You can screen round shot and use only fully formed shot for better shooting. Cal. .177 Darts can be used in this model if metal shanks are smooth (without burrs), so they do not damage Shot Barrel.

WE RECOMMEND CAL. 177 BENJAMIN H-C PELLETS IN No. 130 FOR ACCURATE SHOOTING. Hold gun slightly below level and push solid round end of Pellet forward in breech opening of Shot Barrel with index finger until hollow end of PELLET is flush with opening in Shot Barrel; close Bolt and lock it.

No. 132 BENJAMIN AIR PISTON shoots Cal. .22 BENJAMIN H-C PELLETS; Cal. .22 BENJAMIN DARTS can be used in this model if metal shanks are smooth (without burrs) so they do not damage rifling in Shot Barrel. .22 Darts not available at factory.

No. 137 BENJAMIN AIR PISTON shoots Cal. .177 BENJAMIN H-C PELLETS; Cal. .177 BENJAMIN DARTS can be used in this model if metal shanks are smooth (without burrs) so they do not damage rifling in Shot Barrel.

TO LOAD PELLETS pull Bolt back until it engages Trigger; place BENJAMIN H-C PELLET in breech opening (solid round end forward) ahead of Bolt, push Bolt forward and lock it; this advances Pellet to firing position.

USE BENJAMIN H-C PELLETS FOR BEST RESULTS. WE DO NOT GUARANTEE SATISFACTORY PERFORMANCE WITH INFERIOR AMMUNITION. If your Dealer cannot furnish BENJAMIN H-C PELLETS order direct from FACTORY. DO NOT USE PELLETS OVER AGAIN.

TO LOAD DARTS pull Bolt back until it engages Trigger; push pointed end of Dart in breech end of Shot Barrel until tail clears front end of Bolt; close Bolt and lock it.

ALWAYS KEEP SAFETY ON until you are ready to shoot to prevent accidental discharge.

AFTER PISTON IS LOADED TAKE SAFETY OFF by pushing safety button to left before aiming and firing; IF YOU DO NOT FIRE PUT SAFETY ON AGAIN AND KEEP IT ON until you are ready to shoot.

DO NOT PUT GUN AWAY WHEN LOADED AND DO NOT FIRE UNLESS IT IS CHARGED WITH AIR. This gun has a hair trigger adjusted between 2 and 3 pounds same as used on fire arms. If Valves leak after gun has been stored away it is probably due to loss of elasticity in valve packing and the valves should be replaced. We do not furnish new packing for old valves.

ALL COMPRESSED AIR DEVICES USE A PLUNGER OR PISTON for Compressing Air into a tank of chamber which is equipped with valves, and the valves must be coated to hold air pressure.

THESE GUNS HAVE SELF EXPANDING HYCAR PISTONS. The Air is Compressed with a hand operated Pump and forced into Air Chamber through Inlet Valve. Outlet Valve releases Compressed Air when Gun is Fired.

TO REMOVE PUMP ASSEMBLY pull Pump Lever up as far as it will go; remove No. 1304 Lock Screw from end of No. 1324 Muzzle Plug and push out No. 1311 Plug Hinge Pin, then pull out Muzzle Plug and bring No. 1325 Link Coupling Pin in line with Plug Hinge Pin Hole and push Link Coupling Pin out through this hole, after which take Pump Assembly out.

TO REPLACE PUMP PISTON loosen No. 1321 Pump Lock Nut; detach No. 1351 Pump Piston, remove No. 1334 Felt Oiler and No. 1344 Iron Washer. Put Lock Nut on New Pump Piston and assemble with Iron Washer, also felt Oiler in Link Coupling so that overall length from edge of Link Coupling to edge of Pump Piston measures 2-13/16 inches; be sure to tighten Lock Nut in correct position. Wipe inside of Pump Barrel thoroughly before putting Pump Assembly back as follows: hold Pump Barrel in one hand so that slot in Pump Barrel is up or on top, then rotate Pump Piston gently to and fro, also guide Pump Piston into Pump Barrel with fingers and push Pump Piston in. After this reverse above operations by putting back Link Coupling Pin through Plug Hinge Pin Hole, then put Muzzle Plug in end of Pump Barrel and insert Lever Hinge Pin so that groove is under Lock Screw which will hold it in place when tightened.

IF GUN HAS NOT BEEN USED FOR SOMETIME and cannot be pumped up or does not hold AIR, it can be REPAIRED.

OUR WARRANTY REQUIRES PURCHASERS WRITE FACTORY about NEW GUNS that are not entirely satisfactory. Advise Model and from whom Gun was received or purchased also Price paid and what the Trouble is, etc. so we can recommend proper care or handling of gun.

WE DO NOT REPLACE GUNS or authorize Dealers to exchange them, and we will not Service Guns purchased at Reduced Prices UNDER WARRANTY.

Benjamin Sheridan

Corporation

WE GUARANTEE SATISFACTORY PERFORMANCE AND WILL SERVICE NEW GUNS purchased at Regular Prices FREE OF CHARGE under WARRANTY IF RETURNED TO FACTORY PREPAID within a reasonable time, and Guns have not been damaged or abused and do not show excessive wear.

SOME OF OUR DEALERS are equipped to SERVICE BENJAMIN under WARRANTY and to Repair Current Models. Ask us for location of nearest Authorized Repair Depot in your Area.

YOU CAN MAKE YOUR OWN REPAIRS. ORDER Valve Tool and Parts from Factory if not available from Dealer. Itemize Parts by number in accordance with Price List. Advise Model and enclose payment (including packing and postage) with Order. WE DO NOT SHIP COO.

TO REMOVE VALVES take out all of the parts in breech end of large barrel down to No. 140 Outlet Valve Lock Screw. Place small end of Valve Tool in square hole of Outlet Valve Lock Screw and remove Outlet Valve Lock Screw by unscrewing it. You can hold Valve Tool in vise horizontally and push breech end of large barrel over small end of Valve Tool, then turn gun slowly to left which will loosen Outlet Valve Lock Screw; do not use wrench or pliers on gun. Or you can hold gun barrel in vise between two wooden jaws which have been bored out to accommodate same; do not put a lot of pressure on gun barrel, just enough to hold it safe. Insert small end of Valve Tool in Outlet Valve Lock Screw and remove it by turning Valve Tool slowly to left (with open end wrench) to loosen it. Next you attach small end of Valve Tool (which is bored out and threaded in center) to threaded section of No. 137 Outlet Valve Seat; hold Valve Tool in vise horizontally and pull gun away to remove Outlet Valve Seat; you may tap end of gun barrel lightly around the circumference with a wooden mallet to break lead seal. Outlet Valve Seat was screwed down tight against a lead packing ring by tightening Outlet Valve Lock Screw against it when gun was assembled, and cannot be removed unless these instructions are followed.

VALVE ASSEMBLY WILL FALL OUT by inverting gun barrel. If No. 125 Inlet Valve sticks to Inlet Valve Seat and does not fall out of its own weight, you may be able to jar it loose; or push a thin stiff wire through air intake hole in Inlet Valve Seat against Inlet Valve to loosen it — from muzzle end of large barrel after pump assembly is removed. Wipe out Air Chamber with a soft cloth wrapped around a small stick then clean or replace both valves if necessary.

PUT INLET VALVE BACK IN AIR CHAMBER with packing against Inlet Valve Seat; next comes No. 143 Valve Spring and Outlet Valve; next drop No. 131 Round Lead Packing Ring in Air Chamber; next drop Outlet Valve Seat into position over Outlet Valve Stem, with key fitting in slot in Air Chamber. Attach Tool to threaded section of Outlet Valve Seat and screw it down tight; then tap end of Valve Tool sharply with Hammer to spread Outlet Part Packing Ring. THIS WILL HOLD OUTLET VALVE SEAT IN POSITION. Remove Tool from Outlet Valve Seat; next drop No. 133 Lead Packing Ring (with tongue extension on it that fits into slot of Air Chamber) over end of Valve Seat. Put Outlet Valve Lock Screw on end of Valve Tool and insert it in Air Chamber; tighten Outlet Valve Lock Screw with Valve Tool to spread both Lead Rings. Complete Air Chamber cannot be replaced.

BE CERTAIN THAT AIR CHAMBER IS EMPTY BEFORE REMOVING VALVES.

DO NOT OIL VALVES OR INTERNAL PARTS OF AIR CHAMBER or allow any oil to enter same. We regularly use oil proof valve packing, however, we reserve the right to substitute other suitable materials when it is not available.

IF YOU PREFER TO SHIP GUN DIRECT TO FACTORY FOR ADJUSTMENT OR REPAIRS IT MUST BE FORWARDED BY EXPRESS PREPAID AND we will return it to you Express Collect F.O.B. Factory. Send full instructions by first class mail.

AIR PISTOLS ARE NOT ADMITTED IN U.S. Mail between individuals and Factory under Postal Regulations; we cannot change this situation. AIR PISTOLS CAN BE SHIPPED BY PARCEL POST TO OR FROM FACTORY AND LICENSED FIRE ARMS DEALER.

ASK ANY LICENSED DEALER in your community to ship Air Pistol to Factory by Parcel Post for Adjustment or Repairs when necessary. DEALER MUST ALSO WRITE US at the same time shipment is forwarded and relate any circumstances that will enable us to determine what is wrong.

IF ADJUSTMENT IS EXPECTED UNDER WARRANTY we must have complete information including date when purchased and price paid. Unless instructions are in our hands when gun reaches us we cannot proceed with repairs in the regular way, which entails additional time and expense.

WE DO NOT MAKE PARTIAL REPAIRS and we will not assume any responsibility for satisfactory operation unless we make complete repairs.

WE DO NOT ITEMIZE REPAIRS as it is usually necessary to take each gun down and reassemble it to insure satisfactory operation. We will replace all worn or missing or damaged parts. We will quote net cost of repairs needed upon receipt of gun when requested; otherwise you will be notified amount due us when repairs are completed. We do not ship C.O.D.

WE DO NOT REFINISH or reblue any of our guns or stocks. We do not guarantee finish against wearing off, as this is often due to atmospheric conditions or acidity. You can obtain black acid proof lacquer or air drying enamel from paint store for reconditioning worn parts of gun barrel. Refinish wood handles with linseed oil or lacquer or varnish.

DO NOT WRITE US about repair jobs or orders sent in by Dealers as it would be difficult for us to identify them. Ask the Dealer to write to us and we will give him complete information upon receipt of order number or other references which will enable us to investigate it.

SHOOTING HIGH OR LOW IS NOT A DEFECT and can be easily corrected by drawing a fine or coarse bead on front sight when aiming.

OPEN REAR SIGHT IS ADJUSTABLE FOR ELEVATION AND WINDAGE and can be moved either right or left or up or down. If gun shoots to the right move the rear sight to the left to correct it. If gun shoots high, lower the rear sight to correct it. Before making any sight correction you should have a shot group of 3 or more shots very close together to make sure that you are aiming and squeezing the trigger properly. If gun shoots much too low you can file top of front sight off which will raise muzzle end of gun barrel. You cannot check these guns for accuracy in a vise as it would be almost impossible for anyone to replace the gun in exactly the same position after it has been taken out of the vise for pumping up. The practical way to test these guns for accuracy is to put them in a V rest permanently located on a post or other support and bring shot barrel into the same position for each shot by holding it against a stop.

YOU MAY ORDER TOOLS AND PARTS ALSO SUPPLIES for all Current MODELS from FACTORY, if not available from Dealer or Jobber.

IF SHIPMENT IS RECEIVED IN BAD ORDER FROM US or you discover that the contents are damaged be sure to notify the Postmaster or Express Agent in your city immediately, also write us promptly and return the damaged goods to us PREPAID, and we will file claim for damages.

IF YOU INQUIRE ABOUT ORDERS for guns or parts or tools and supplies, give us the date on which the order was sent in and enclose another list, also advise amount paid and in what form payment was made — either by money order, bank draft, personal check, currency, coin or postage. If payment was made by money order or check, ask the postmaster or bank in your city to investigate whether or not the money was paid to us, and include this information when writing about it.

Benjamin Sheridan Corporation

PART NO 166-130

PART NO 166-132

PART NO 166-137

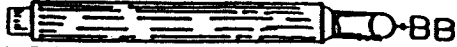

LSO USED ON 132 AFTER 1951
LSO USED ON 137 AFTER
1951 TO 6-1-55

USED ON 132 PRIOR TO 1952

USED ON 137 UNTIL 1951
USED ON 137 AFTER 1951

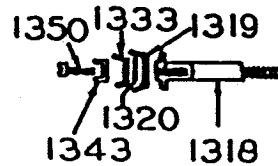
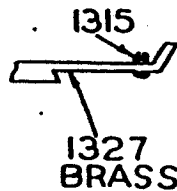
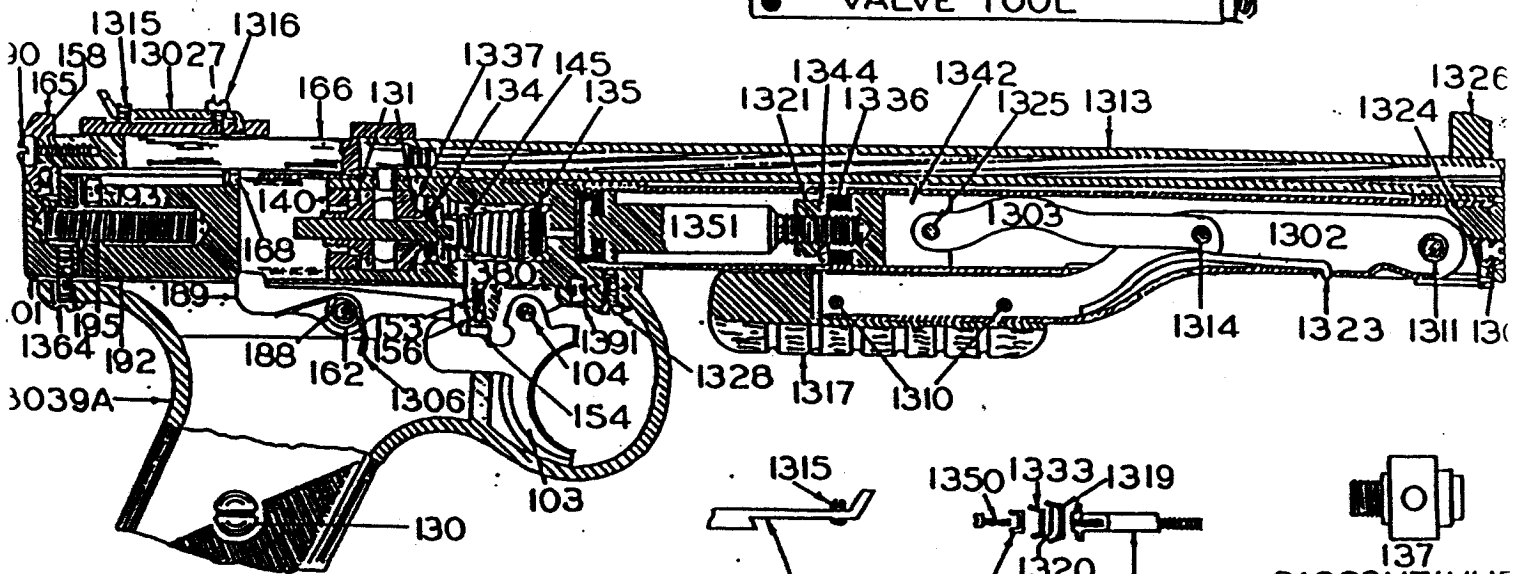
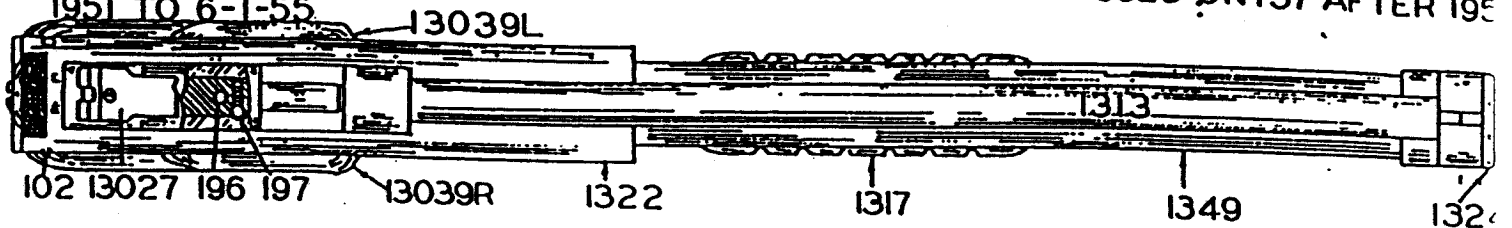

PART NO 166-130

PART NO 166-132

PART NO 166-137 177



ALSO USED ON 132 AFTER 1951
ALSO USED ON 137 AFTER
1951 TO 6-1-55

USED ON 132 PRIOR TO 1952

USED ON 137 UNTIL 1952
USED ON 137 AFTER 1955

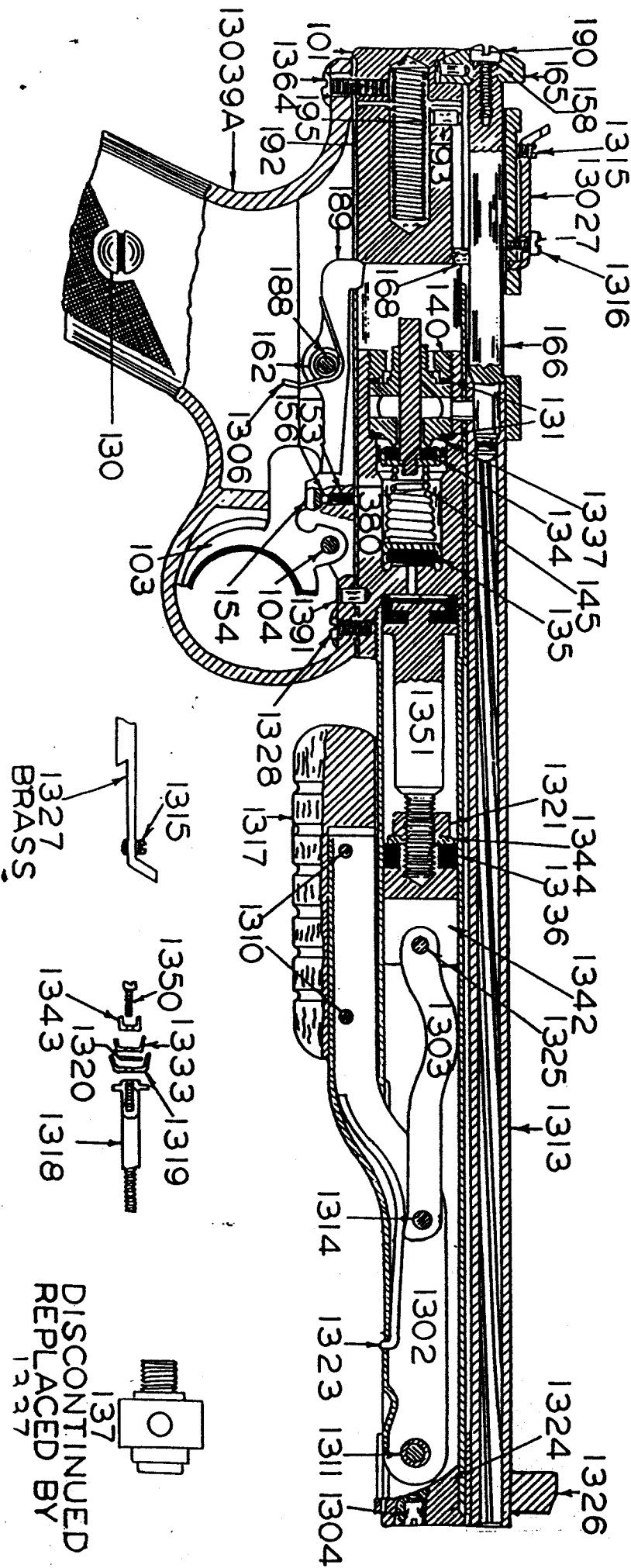
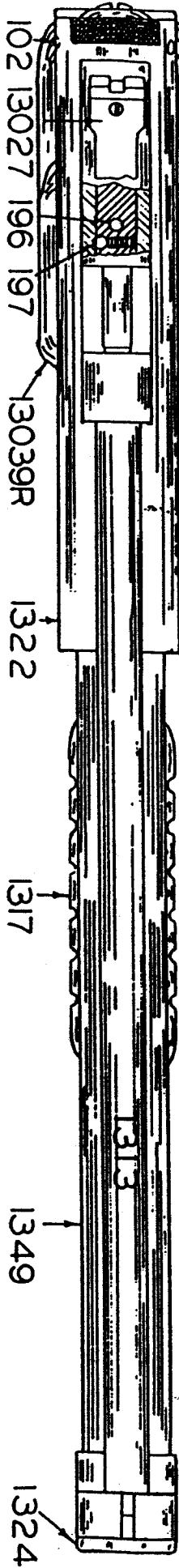

DISCONTINUED
REPLACED BY
137
1227

NOS. 130-132-137 REPAIR PARTS—DESCRIPTION OF PARTS AND PR

Parts marked* not subject to replacement — do not order

101 Breech Cap	166-132 Bolt (Used on Model	1326 Front Sight
102 Breech Cap Screws . . . ea.	132 prior to 1952)	1327 Rear Sight, Brass (
103 Trigger	166-137 Bolt (Used on Model	be used on gun eq
104 Trigger Pin	137 until 1952) (Used on	with No. 13027 Rec
106 Trigger Spring (Not shown-	Model 137 after 1955)	No substitutions pos
used on 130-132-137 prior	168 Bolt Guide Screw	1328 Front Assembly Screw
to 1955)	188 Trigger Relay Pin	1331 Outlet Valve Lock Nut
109 Stock Washers (Not shown-	189 Trigger Relay (Sear)	Packing Ring
used on 130-132-137 prior	includes 162	1333 Pump Expander
to 1955) ea.	190 Bolt Button Screw	1336 Felt Oiler
128 Front Assembly Screw (Not	192 Hammer	1337 Outlet Valve Seat (Will fi
shown-used on 130-132-	193 Hammer Pin	all Models)
137 prior to 1955)	195 Hammer Spring	1339A Stock Frame (Not shown-
130 Stock Screws ea.	196 Bolt Friction Spring	used on 130-132-137 pri
131 Outlet Port Packing Ring .	197 Ball Bearing	to 1955) Not available.
134 Outlet Valve	1302 Pump Lever	1339L Left Hand Stock-Wooden
135 Inlet Valve	1303 Pump Link	(Not shown-used on 130
137 Outlet Valve Seat (Discon-	1304 Lever Hinge Pin Lock Screw	132-137 prior to 1955) N
tinued - Reorder No. 1337)	1306 Trigger Spring	1339R Right Hand Stock-Wooden
140 Outlet Valve Lock Screw .	1308 Air Chamber	(Not shown-used on 130
145 Valve Spring	1310 Handle Pins	132-137 prior to 1955) N
153 Safety Spring	1311 Lever Hinge Pin	1342 Link Coupling
154 Safety Button	1313 Shot Barrel	1343 Brass Washer
156 Ball Bearing	1314 Link Hinge Pin	1344 Small Iron Washer
158 Bolt Button Spring Washer.	1315 Rear Sight Adjustment Screw	1349 Pump Barrel
162 Relay Bearing	1316 Rear Sight Fastening Screw	1350 Pump Rod Screw
164 Rear Assembly Screw (Not	1317 Lever Handle	1351 Pump Piston
shown-used on 130-132-	1318 Pump Rod	1364 Rear Assembly Screw . .
137 prior to 1955)	1319 Leather Washer	1391 Frame Dowel Pin
165 Bolt Button	1320 Leather Lock Washer	13027 Rear Sight (Steel)
166-130 Bolt (Used on all	1321 Pump Lock Nut	13039A Stock Frame (since 1955)
Model 130) (Also used on	1322 Barrel	13039L Left Hand Stock, Plastic
Model 132 after 1951)	1323 Link Spring	(since 1955)
(Also used on Model 137	1324 Muzzle Plug	13039R Right Hand Stock, Plastic
after 1951 to 6-1-1955) . .	1325 Link Coupling Pin	(since 1955)

YOU CAN ORDER AMMUNITION AND SUPPLIES FROM FACTORY if your local Dealer is unable to supply same. (Price subject to changes) — **MINIMUM ORDER \$5.00. MAY INCLUDE PARTS, AMMO AND ACCESSORIES SHIPPED PREPAID.**

AMMUNITION AND TOOLS

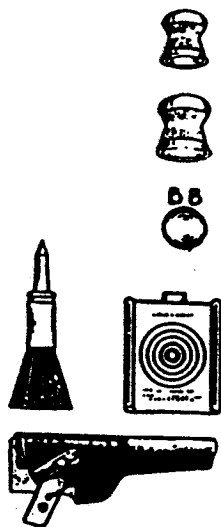

BENJAMIN H-C LEAD PELLETS, Cal. .177-500
BENJAMIN H-C LEAD PELLETS, Cal. .177-250
BENJAMIN H-C LEAD PELLETS, Cal. .22-500
BENJAMIN H-C LEAD PELLETS, Cal. .22-250
BENJAMIN Steel Air Rifle Shot, per lb.
BENJAMIN Steel Air Rifle Shot, per 500
BENJAMIN Lead Air Rifle Shot, per lb.
BENJAMIN Lead Air Rifle Shot, per 500
BENJAMIN Steel Darts, Cal. .177, per dozen
BENJAMIN Steel Darts, Cal. .22, per dozen
BENJAMIN Bulls-Eye BELL TARGET. Each
BENJAMIN Paper Target Inserts, 25 Ft. Pistol, per 100-
per 500-
per 1000
BELT TYPE LEATHER HOLSTER with snap buttons on belt loop and safety strap.	
R or L; ADVISE MODEL when ordering to obtain correct size
Combination Valve Tool for Removing Outlet Valve Lock Screw and	
Extracting Outlet Valve Seat
Combination Valve Tool
One No. 134 Outlet Valve
One No. 131 Outlet Port Packing Ring
One No. 1331 Outlet Valve Lock Nut Packing Ring
One No. 1351 Hy-Car Pump Piston
One No. 1336 Felt Oiler
One No. 135 Inlet Valve

We Recommend The Following Parts For Valve Overhaul.

ENCLOSE PAYMENT WITH DIRECT ORDERS TO BE SHIPPED FROM FACTORY.

ALLOW TIME FOR PERSONAL CHECKS TO CLEAR. Send Money Order, Postal Note or Bank Draft with orders if shipment is wanted. We will not assume responsibility for loss of Currency or Coin or Stamps included with orders by mail. Include Sales Tax with orders from Mo. WE DO NOT SHIP C.O.D.

► "Benjamin Air Rifle Company is not responsible on its warranty to any purchaser or user who tampers with, modifies or uses this product for any other purpose than that for which it was intended."

BENJAMIN AIR RIFLE CO.

1525 So. 8th St.

St. Louis, Mo. 6