



Model 2100 Classic™ OWNER'S MANUAL

**READ ALL INSTRUCTIONS AND WARNINGS IN
THIS MANUAL BEFORE USING THIS AIRGUN.**

CONGRATULATIONS

And thank you for choosing Crosman Airguns Model 2100 Classic™ BB/pellet air rifle.

The Model 2100 Classic includes many up-to-date features which will mean easier handling, greater accuracy and more enjoyment for you.

- Most powerful 17-shot BB repeater made
- Solid steel rifled barrel for greater accuracy
- Spring fed BB magazine for convenient loading
- Sights adjustable for both windage and elevation
- Receiver grooved for scope mounting
- Shoots both BBs and .177 caliber pellets

To get the most enjoyment from your new airgun, please read this owner's manual completely. And remember, the Model 2100 Classic is not a toy. Treat it with the same respect you would a firearm. Always carefully follow the safety instructions found in this owner's manual and keep this manual in a safe place for future use.

Thank you for choosing a Crosman airgun.

⚠ WARNING: NOT A TOY. ADULT SUPERVISION REQUIRED. MISUSE OR CARELESS USE MAY CAUSE SERIOUS INJURY OR DEATH. MAY BE DANGEROUS UP TO 475 YARDS (435 METERS).

READ ALL INSTRUCTIONS BEFORE USING.

BUYER AND USER HAVE THE DUTY TO OBEY ALL LAWS ABOUT THE USE AND OWNERSHIP OF THIS AIRGUN.

THIS AIRGUN IS INTENDED FOR USE BY THOSE 16 YEARS OF AGE OR OLDER.

2

STEPS FOR SAFE SHOOTING

| | Page |
|---|-------|
| Step 1. Learning the Parts of Your New Rifle..... | 4 |
| Step 2. Operating the Safety | 5 |
| Step 3. Pumping the Rifle | 6 |
| Step 4. Loading and Unloading BBs | 7-8 |
| Step 5. Loading and Unloading Pellets | 9 |
| Step 6. Aiming and Firing Safely..... | 10-11 |
| Step 7. Removing a Jammed BB or Pellet..... | 11 |
| Step 8. Maintaining your Rifle..... | 12-14 |
| Step 9. Reviewing Safety..... | 15 |
| Step 10. Using and Enjoying Your Rifle | 16-17 |

Step 1. Learning the Parts of Your New Rifle

Learning the names of the parts of your new rifle will help you to understand your owner's manual. Use this manual to increase your airgun enjoyment.

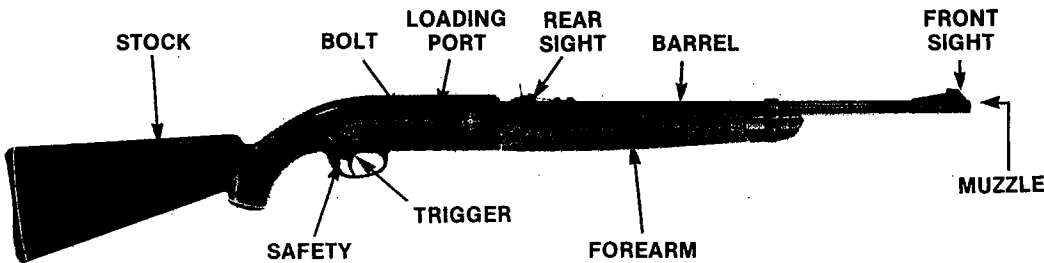

Model 2100 Classic™

3

Step 2. Operating the Safety

- A. To put the rifle "On Safe", locate the safety directly behind the trigger. Push the safety from the left side all the way in. (Fig. 1) The safety is not on unless it is pushed all the way in and the red ring around the safety is not showing. The rifle will not fire when "On Safe".
- B. Even when the safety is "On Safe" you should continue to handle the rifle safely. Don't point the gun at anything you don't intend to shoot.
- C. To take the rifle "Off Safe", push the safety from the right side all the way in. When you can see the red ring around the safety, the rifle is "Off Safe" and will fire.

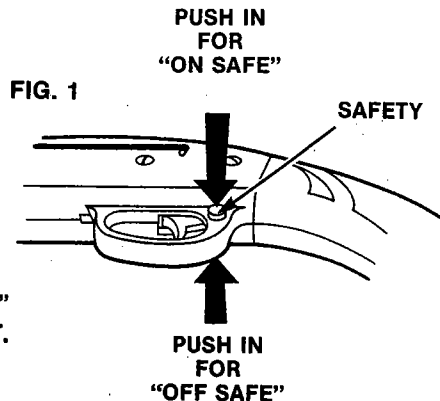

⚠ WARNING: KEEP THE RIFLE "ON SAFE" UNTIL YOU ARE ACTUALLY READY TO SHOOT. THEN PUSH IT TO "OFF SAFE".

Step 3. Pumping the Rifle

- A. Put the rifle "On Safe".
- B. Open the forearm all the way until it stops. (Fig. 2) Close it with a smooth stroke. Don't pinch hand or fingers when the forearm closes. Keep your finger off the trigger while pumping.
- C. Be sure to use at least 2 pumps to keep the barrel from jamming with a pellet or BB.
- D. Do not twist forearm while pumping. Use straight strokes to prevent breakage.

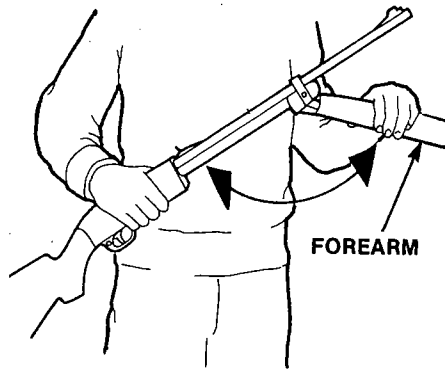

FIG. 2

⚠ WARNING: NEVER PUMP YOUR GUN MORE THAN 10 TIMES. OVER-PUMPING GIVES ONLY A SLIGHT INCREASE IN POWER AND WILL CAUSE MAJOR DAMAGE TO YOUR GUN. PUMPING MORE THAN 10 TIMES MAY ALSO LEAVE A SMALL AMOUNT OF AIR IN THE GUN WHICH MAY ALLOW YOU TO FIRE A SECOND SHOT WITHOUT ADDITIONAL PUMPING.

6

Step 4. Loading and Unloading BBs

A. Loading BBs

- Put rifle "On Safe".
- Slide grip cap toward the rear of the rifle. (Fig. 3)
- Pour no more than 200 BBs into reservoir hole. Do not put pellets in reservoir hole. They will jam the reservoir.
- Close grip cap.
- Pull BB follower stem back and latch in notch. (Fig. 4)
- Point the barrel straight down.
- With hand twisting motion shake and twist the rifle (Fig. 4) to fill the visual magazine.
- Take BB follower stem out of notch and release it to hold BBs in visual magazine.
- Cock the bolt by pushing it all the way back. The magnetic bolt will pick up a BB.
- Push the bolt all the way forward slowly and you will see the BB move through the loading port. (Fig. 5) The BB is now in a position to be fired out the barrel.

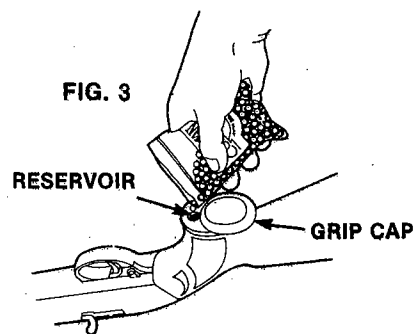

FIG. 3

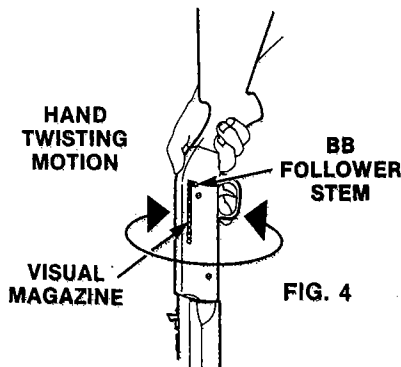
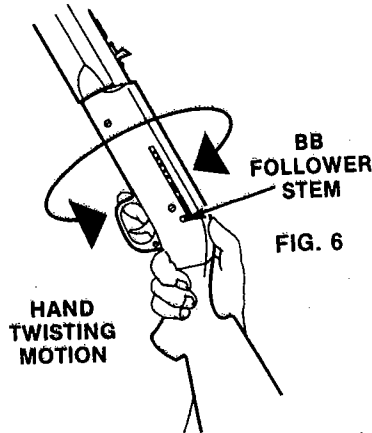
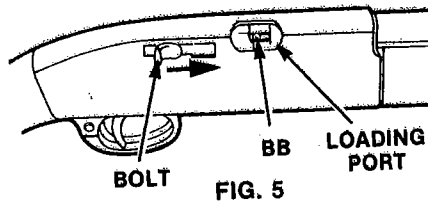

FIG. 4

7

B. Unloading BBs

- Pump the rifle, cock the bolt, point the rifle in a safe direction and fire. This will unload the BB from the magnetic bolt.
- Put the rifle "On Safe".
- Pull the BB follower stem back and latch it in the notch.
- Tilt the barrel upward.
- With hand twisting motion, shake and twist the rifle until all the BBs are out of the visual magazine. (Fig. 6)
- Check to see if there are any BBs in the visual magazine. If there are still BBs in the magazine repeat the unloading procedure until the magazine is empty.
- Take the BB follower stem out of the notch and release it to block BBs from the visual magazine.
- Pull the bolt to the rear and check once again to see if there is a BB on the magnetic bolt. If there is, pump the rifle, cock the bolt, point the rifle in a safe direction and fire.



8

Step 5. Loading and Unloading Pellets

A. Loading Pellets

- Unload the BBs from the rifle. (See Step 4B)
- Put the rifle "On Safe".
- Point the rifle in a safe direction.
- Pull the bolt all the way back.
- Place one pellet, nose forward, in the loading port. (Fig. 7)
- Push the bolt all the way forward. The pellet is now in a position to fire out the barrel.

B. Unloading Pellets

- Pump the rifle, cock the bolt, point the rifle in a safe direction and fire. This is the only way to unload pellets.

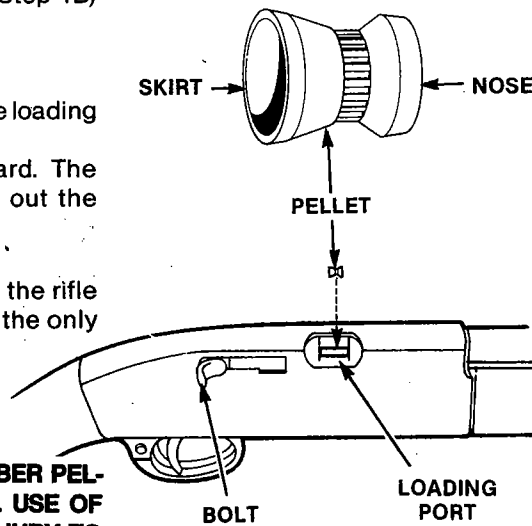

CAUTION: USE BBs OR .177 CALIBER PELLETS ONLY. NEVER REUSE AMMUNITION. USE OF ANY OTHER AMMUNITION CAN CAUSE INJURY TO YOU OR DAMAGE TO THE RIFLE.

Step 6. Aiming and Firing Safely

A. Aiming the Rifle

Always aim your rifle in a **SAFE DIRECTION**. When you are sure of your target and backstop, and the area around the target is clear, take the rifle "Off Safe" (see Step 2) and squeeze the trigger to fire.

Don't shoot at hard surfaces or at the surface of water. The BB or pellet may bounce off and hit someone or something you had not intended to hit.

The rifle is correctly aimed when the front sight blade is positioned exactly in the notch of the rear sight. The top of the front sight blade should be even with the top of the notch in the rear sight. The bullseye should appear to rest on the top of the front sight. (Fig. 8)

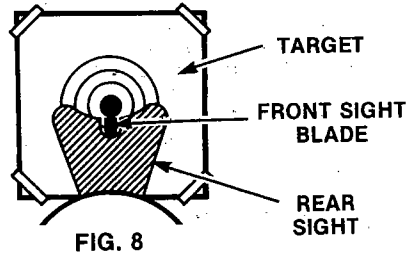

B. Sight Adjustment

The rear sight may be adjusted to shoot higher or lower (elevation). Move the rear sight elevator back to make the BB or pellet hit higher on the target. Move the rear sight elevator forward to make the BB or pellet hit lower on the target. When moving the elevator, slightly lift the rear sight and reset it on the desired notch in the elevator. (Fig. 9)

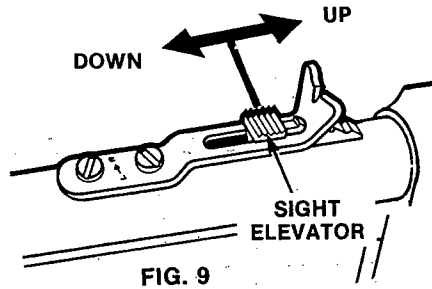

10

9

The rear sight may also be adjusted to shoot right or left (windage). Loosen the windage adjustment screws by turning them counterclockwise. Move the sight to the right to make the BB or pellet hit to the right on the target. Move the sight to the left to make the BB or pellet hit to the left on the target. Then tighten the windage adjustment screws by turning them clockwise. (Fig. 10)

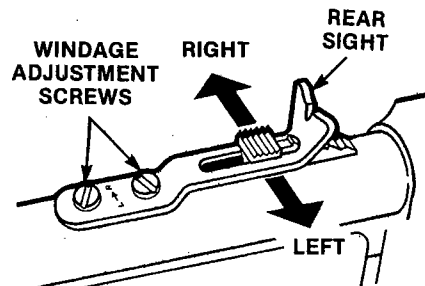

Step 7. Removing a Jammed BB or Pellet

- Don't reload.
- Put the rifle "On Safe".
- Unload the BBs from the visual magazine. (see Step 4B).
- With the rifle "On Safe", pump 10 times, cock the bolt, aim in a **SAFE DIRECTION**, take "Off Safe", and fire.

ROD

- Put the rifle "On Safe", open the bolt, insert a rod or straightened clothes hanger into the barrel and carefully push the jammed pellet or BB into the loading port. Don't try to reuse that pellet or BB again. (Fig. 11)

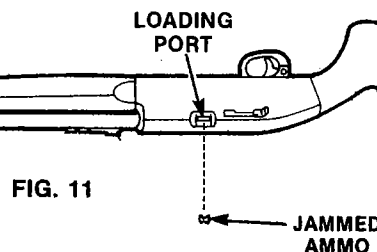

Step 8. Maintaining Your Rifle

Trouble Shooting Guide

| PROBLEMS | REASONS | | | | | | | | | | | | | | |
|-------------------------|-----------------------|----------------|-----------------------|----------------|---|----------------|-------------------------|---------------------|--------------------|--------------------------|--------------------------------|--------------------------------|----------------------------------|---------------------|---------------------------------|
| | Safety in On Position | Gun Not Cocked | Bolt in Open Position | Gun Not Pumped | Gun Not Pumped to Recommended number of pumps | Bolt Unlatched | Barrel Plugged (Jammed) | Lack of Lubrication | Re-Used Ammunition | Pellets Loaded Backwards | Use of Wrong Type or Cal. Ammo | Shooting Pellet BB Combination | Loading More Than One Projectile | Sights Not Adjusted | Ammunition Not In Fire Position |
| INACCURACY | | | | • | • | | | • | • | • | • | • | • | | |
| GUN FAILS TO SHOOT | • | • | • | • | • | • | • | • | • | • | • | • | | | • |
| LOW POWER | | | | • | • | | • | • | • | • | • | • | | | |
| BARREL PLUGGED (Jammed) | | | | • | | | | • | • | • | • | • | | | |

12

Your rifle will work best if you oil it every 250 shots. Put 2 to 3 drops of Crosman Pellgunoil on the pump pivot pins and the oil retainer in the pump mechanism. A little oil on the barrel helps prevent rust. Pellgunoil is best, but any light household oil is better than none. Don't over-oil. This can cause damage to your rifle. (Fig. 12)

Tampering with the gun or attempts to change the gun in any way make it unsafe to use. If you drop your gun, check it to see that it works properly before you use it again. If anything seems changed, like a shorter or weaker trigger pull, this may mean worn out or broken parts. Don't use it again until you've had it checked by an Authorized Service Station. (A list of Service Stations is in the box with the Rifle.)

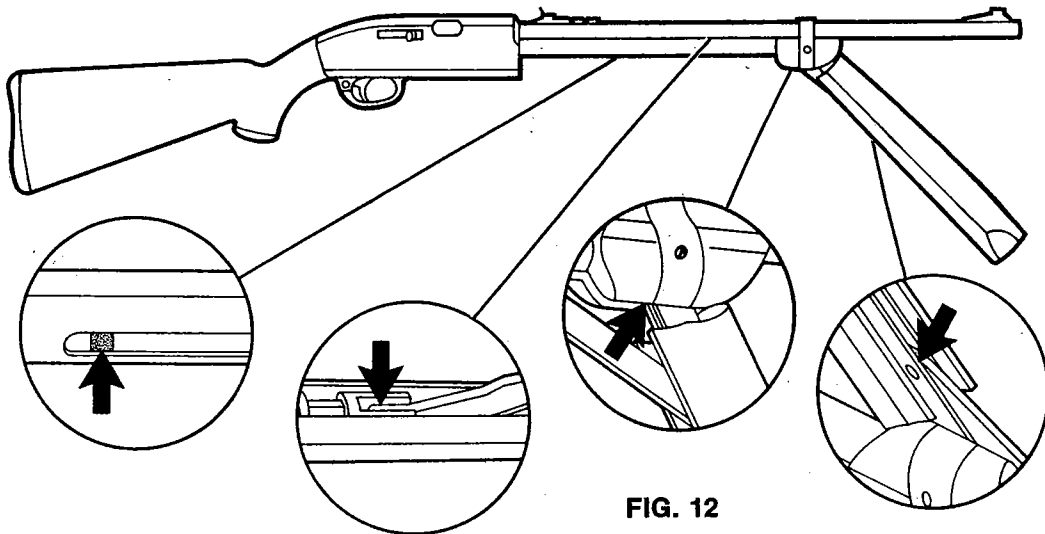

FIG. 12

Step 9. Reviewing Safety

- Don't point at anything you don't intend to shoot. Always aim in a SAFE DIRECTION.
- Don't pinch hands or fingers when closing forearm.
- Use BBs or .177 caliber pellets only. Never reuse ammunition.
- Don't shoot at hard surfaces or at the surface of water. The BB or pellet may bounce off and hit someone or something you had not intended to hit.
- Always keep gun "On Safe" until you are ready to shoot.
- Stop using a backstop if it becomes worn. Place backstop in a location that will be safe should the backstop fail.
- Do not attempt to disassemble or tamper with your gun. Use a competent repairman.
- Always handle your rifle as though it were loaded.
- Always check to see if the rifle is "On Safe" and unloaded when getting it from another person or from storage.
- Don't put the rifle away loaded. Make sure all of the BBs and pellets are unloaded. (Step 4B and Step 5B). Also unload the BBs from the reservoir before storing your rifle.

Step 10. Using and Enjoying Your Rifle

Now that you have studied your owner's manual and understand how to use your rifle properly, you are ready to begin your shooting enjoyment. Follow these shooting tips for fun and safe shooting.

Choosing Targets

Always choose your targets carefully. It is best to shoot at paper bullseye targets which are attached to a safe backstop such as the Crosman Target Trap. A heavy blanket should be hung behind the target trap to prevent ricochet or BBs or pellets bouncing off should you miss the backstop. It is also best to wear shooting glasses to protect your eyes.

Don't shoot at hard surfaces or at the surface of water. The BB or pellet may bounce off and hit someone or something you had not intended to hit.

Your backstop should be checked for wear before and after each use. Stop using any backstop if the surface is worn or damaged or if the BB or pellet bounces off or ricochets.

Your airgun is designed for target shooting and is suited for both indoor and outdoor use. Always remember to place your target carefully. **THINK** what you will hit if you miss the target!

Shooting

We talked earlier about aiming your rifle and sight adjustment (Step 6). The next step is putting the sights together with the target. This is known as sight picture.

15

A correct sight picture has the bullseye directly centered on top of the front sight with both sights correctly aligned. (Fig. 13)



Now with the sights and target in the proper position, you are ready to squeeze the trigger.

A trigger must be squeezed smoothly to keep the sights aligned and on the target as the gun fires.



Proper breathing is important for good marksmanship. Take a deep breath, let it out until you are comfortable, then hold it until after you have fired. Keep holding your breath and squeezing the trigger for a second or two after firing the shot. This is called follow through and is important for smooth and accurate shooting.

Shooting Games

Competing with friends and holding informal shooting matches can make airgun ownership more fun and exciting. Crosman silhouette targets and Crosman Shooting Games will help make your neighborhood matches the most popular around.

REMEMBER....shooters are made, not born. Know the basics of safe

SPECIFICATIONS

| | |
|-----------------|---|
| Mechanism: | Bolt Action |
| Caliber: | .177 |
| Ammunition: | BB cal. (4.5 mm) Steel Airgun Shot  .177 cal. (4.5 mm) Lead Airgun pellet  |
| Reservoir: | 200 BBs |
| Magazine: | 17 BBs |
| Weight: | 4 lbs. 13 oz. (2.18 kg) |
| Overall Length: | 39 3/4 in. (101 cm) |
| Sights: Rear: | Fully Adjustable |
| Front: | Ramped Blade |
| Barrel: | 20.84" (52.93 cm) rifled steel |
| Power Source: | Pneumatic Pump Action |

REPAIR SERVICE

If your gun needs repair, we recommend you take or send it to your nearest Crosman Authorized Service Center, (list of service centers in box with gun). Your gun requires special tools and fixtures to repair it. If you take it apart, you probably will not be able to reassemble it correctly. Crosman assumes no warranty responsibility in this case.

PERFORMANCE

| Pumps | Muzzle Velocity (FPS) | Projectile | Weight |
|-------|-----------------------|-------------|---------|
| 3 | 440-520 | .177 BB | 5.5 gr. |
| 6 | 590-650 | .177 BB | 5.5 gr. |
| 10 | 690-755 | .177 BB | 5.5 gr. |
| 3 | 420-480 | .177 Pellet | 7.9 gr. |
| 6 | 565-635 | .177 Pellet | 7.9 gr. |
| 10 | 660-725 | .177 Pellet | 7.9 gr. |

Many factors affect velocity, including brand of projectile, oiling of gun, barrel condition and temperature.

A SPECIAL CUSTOMER SERVICE

Crosman Authorized Service Stations will unjam your rifle at no cost during the warranty period.

18

LIMITED ONE YEAR WARRANTY

This product is warranted to the retail consumer for one year from date of retail purchase against defects in material and workmanship and is transferable. To register the serial number of your gun, please return the Airgun registration form. The warranty is not conditioned on the return of the card.

WHAT IS COVERED

Replacement parts and labor. Transportation charges to consumer for repaired product.

WHAT IS NOT COVERED

Transportation charges to Crosman for defective product. Damages caused by abuse or failure to perform normal maintenance — see Owner's Manual. Sales outside of the United States. Any other expense. CONSEQUENTIAL DAMAGES, INCIDENTAL DAMAGES, OR INCIDENTAL EXPENSES, INCLUDING DAMAGE TO PROPERTY. SOME STATES DO NOT ALLOW THE EXCLUSION OR LIMITATION OF INCIDENTAL OR CONSEQUENTIAL DAMAGES, SO THE ABOVE LIMITATION OR EXCLUSION MAY NOT APPLY TO YOU.

HOW TO OBTAIN WARRANTY PERFORMANCE

Locate nearest Crosman Service Center on list with Product or in phonebook. Attach to Product your name, address, description of problem, phone number and proof of date of retail purchase (sales slip). Package and return Product to Crosman Service Center, transportation charges prepaid.

IMPLIED WARRANTIES

ANY IMPLIED WARRANTIES, INCLUDING THE IMPLIED WARRANTIES OF MERCHANTABILITY AND FITNESS FOR A PARTICULAR PURPOSE, ARE LIMITED IN DURATION TO ONE YEAR FROM DATE OF RETAIL PURCHASE. SOME STATES DO NOT ALLOW LIMITATIONS ON HOW LONG AN IMPLIED WARRANTY LASTS, SO THE ABOVE LIMITATIONS MAY NOT APPLY TO YOU.

To the extent any provision of this warranty is prohibited by federal, state, or municipal law which cannot be preempted, it shall not be applicable. This warranty gives you specific legal rights, and you may also have other rights which vary from state to state.