

Phase I
380 + 38T .22 cal.

Crosman
OWNERS MANUAL

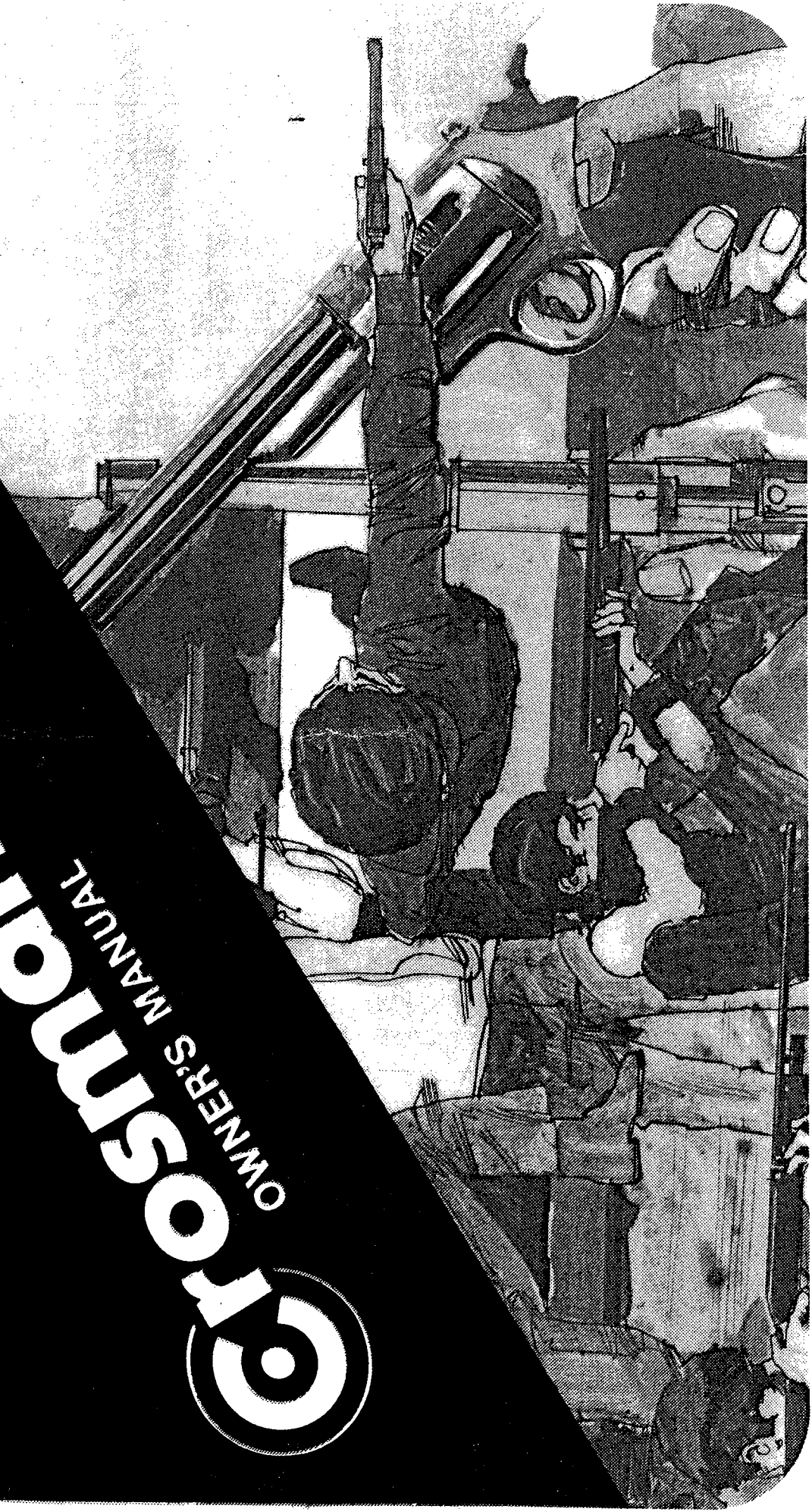

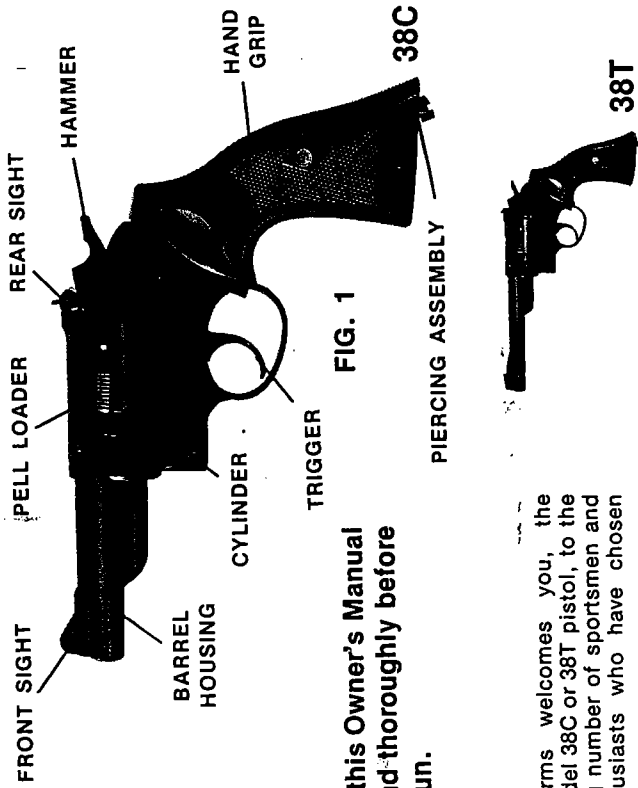

FIG. 1

Please read this Owner's Manual carefully and thoroughly before operating gun.

Crosman Arms welcomes you, the owner of a Model 38C or 38T pistol, to the ever increasing number of sportsmen and shooting enthusiasts who have chosen Crosman guns.

SPECIFICATIONS

Before your revolver was released from our factory, it underwent numerous rigid inspections and was test fired to guarantee its performance. Your revolver is under compression at the time of purchase, as a POWERLET® was fitted at the factory to provide power for factory testing. Residual CO₂ contained in the gun must be completely used or exhausted before removing POWERLET® for recharging. Refer to complete instructions in this manual.

With normal care and maintenance your 38 revolver will last a lifetime and provide endless pleasure. You are urged to use the revolver with respect for other people and to exercise caution and common sense at all times. Care should be taken not to alter or adjust any of the factory settings to the trigger, or to interfere with any other part of the gun that may impair its safe operation.

Mechanism	Double and single action
Caliber	.22
Ammunition	Crosman SUPER PELLs®
Cylinder Capacity	6 pells
Weight	2 lb. 6 oz. (1.1 kg)
Model 38C	2 lb. 10 oz. (1.2 kg)
Model 38T	
Overall Length	
Model 38C	9½ in. (240mm)
Model 38T	11¾ in. (300mm)
Sights	Open type
Rear	fully adjustable for elevation and windage
Front Ramp	
Barrel Length	
Model 38C	3¾ in. (95mm)
Model 38T	6 in. (152mm)
Barrel Rifling	10 lands right hand twist, one turn in 16 in. (405mm)
Trigger Pull	Combat quality
Power Source	One Crosman 12.5 gr. CO ₂ POWERLET®
Number of Shots per POWERLET®	Approximately 45

SHOOTING THE 38

To Load The Revolver

Pull back the Hammer to the first notch position (first click), approximately 1/16 in. (2mm).

CAUTION: This feature is not a Safety, but it will prevent the Hammer from firing the revolver if the gun is accidentally dropped or if the Hammer is pushed. However, the revolver will fire if the Trigger is pulled.

With the revolver pointed in a safe direction, slide the Pell Loader back toward the Hammer and hold it in this position. Drop a Crosman SUPER PELL[®], nose toward the muzzle, into the Loading Port (Fig. 2). Slide the Pell Loader forward to seat the pellet properly in the Cylinder chamber. Rotate the Cylinder to the next click stop to align the Cylinder chamber with the Loading Port. Repeat the procedure until all the chambers are loaded. The loader will return to the

FIG. 2

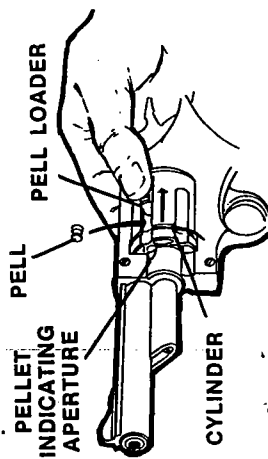

forward position to prevent the pellets from dropping out of the Loading Port. Pellets can be seen in the Cylinder chambers through the Pell Indicating Aperture.

To Unload The Revolver

Set the Hammer to the first notch position. Hold the revolver so that the muzzle is pointing upward and the loading port is tilted slightly downward. Rotate the Cylinder to align each loaded Chamber with the loading port. Slide the Pell Loader back and hold it back. Move the Cylinder back and forth on its axis, but without indexing the Cylinder, and each Pellet will generally return into the loading port from its chamber. Repeat this operation to unload other Cylinder chambers. Stubborn pellets may be removed by inserting a small diameter tool into the Pell Indicating Aperture and pushing the pellet out into the loading port. A small nail, paper clip or hairpin make suitable tools for this operation.

To Shoot The Revolver

For single action shooting, point the revolver in a safe direction, pull back the Hammer with the thumb to the fully rearward position. This action revolves the Cylinder, placing the next pellet in line with the Barrel, locks the Cylinder in position and cocks the revolver ready to fire. When you are sure of your target and backstop, take aim and squeeze the Trigger gently to fire. For double action shooting, level the revolver at the target. When you are sure of your target and backstop, take aim and squeeze the Trigger to fire. The Hammer action, Cylinder indexing and firing operations will be accomplished as rapidly or as slowly as you squeeze the Trigger.

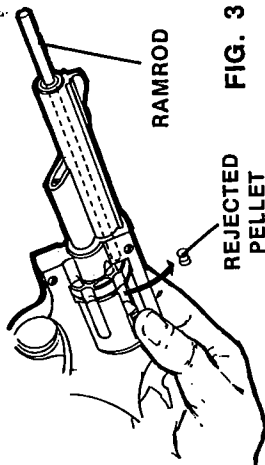

FIG. 3
REJECTED
PELLET

To Unload a Pellet From The Barrel

If a pellet or obstruction becomes lodged in the barrel, set the Hammer to the first notch position. Exhaust the CO₂ gas and remove the POWERLET® as described in the section, "To Exhaust CO₂ Gas". Rotate the Cylinder to align an empty chamber with the Barrel. Insert the ramrod provided with your revolver into the muzzle end of the Barrel. Push the obstruction gently back into the empty chamber (Fig. 3). Rotate the Cylinder to align the chamber with the loading port and remove the obstruction as described in the section, "To Unload The Revolver".

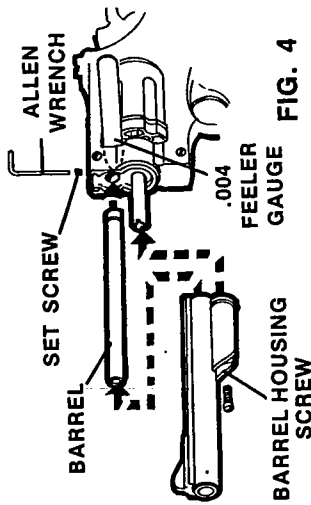

FIG. 4
BARREL HOUSING
SCREW

An obstruction may be cleared also by removing the barrel housing. Release and remove the Barrel Set Screw and the Barrel Housing Screw. Withdraw the barrel housing from the revolver frame. Insert the ramrod provided with your revolver and push out the obstruction. Reassemble the barrel housing to the revolver frame and secure with the Barrel Set Screw and the Barrel Housing Screw. Use a shim stock or feeler gauge to assure a clearance of .004 in. (0.1mm) between the Cylinder and the Barrel (Fig. 4).

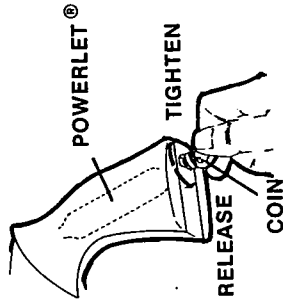

FIG. 5

To Charge Revolver With CO₂ Gas

Before replacing a CO₂ gas POWERLET® proceed as detailed in the following instructions.

To Exhaust CO₂ Gas

Point the revolver in a safe direction and set the Hammer to the first notch position. For maximum safety, remove all the Pellets from the Cylinder as described in the section, "To Unload The Revolver". Use a

small coin and turn the Piercing Assembly slowly counterclockwise until the gas can be heard to be escaping. Continue to back off the Piercing Assembly until all the CO₂ gas is exhausted. Then turn the assembly counterclockwise to the full extent of its travel (Fig. 5).

CAUTION: Do not allow exhaust gas to come in contact with the flesh as exhaust CO₂ gas can cause frostbite.

USE CROSMAN POWERLETS® ONLY

To ensure performance CO2 cartridges, made by Crosman for Crosman guns. Berma-Lok caps assure positive locking, clean piercing. Zinc-chromium plating, no rust, scale or grease.

12.5 gram "glass" size
box of 5-M 231/5

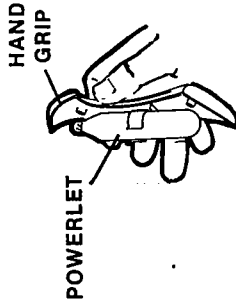
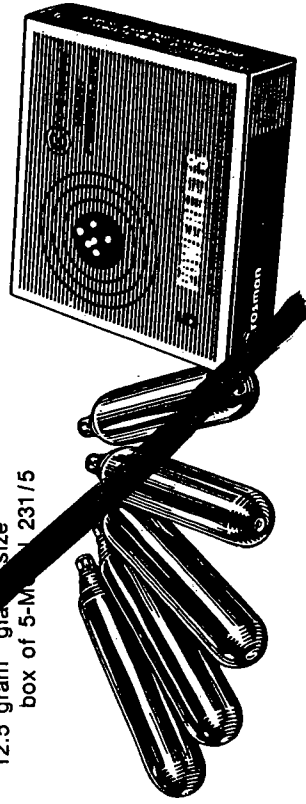

FIG. 6

Remove left hand-grip; the empty POWERLET® cartridge will come away with the hand-grip. Remove the POWERLET®, and press the grip into position by exerting pressure on its center (Fig. 6).

To Replace The Powerlet

Insert a new POWERLET® with neck pointing upward into the Valve Body. Replace the hand-grip, pressing into place so the clip will grip the POWERLET®. By means of a small coin, turn the Piercing Assembly rapidly in a clockwise direction until the POWERLET® is secure. This action also pierces the POWERLET®.

To determine that the POWERLET® is properly pierced, point the revolver in a safe direction and squeeze the Trigger to

fire. If the revolver does not fire it is most probable that the POWERLET® is not pierced. Pull back the Hammer to the first notch position; using a small coin, again turn the Piercing Assembly clockwise until the POWERLET® is pierced and completely secure. DO NOT use a screwdriver or other tools to turn the Piercing Assembly as damage to the internal components of your revolver can be caused.

SIGHTING-IN THE 38

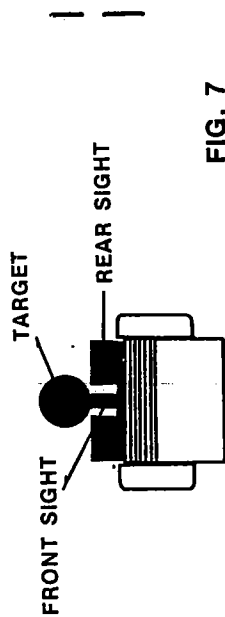

FIG. 7

When taking aim it is important to stand steady with the feet comfortably apart. Grip the revolver firmly and extend your arm fully to the side at shoulder level and point directly at the target. Line up a perfect sight picture. Place your other hand on your hip with your elbows slightly bent. The revolver is correctly aimed when the blade of the Front Sight is positioned exactly in the notch of the Rear Sight, and the top of the Front Sight is flush with the

top of the Rear Sight. For target shooting, many marksmen prefer to sight-in at the bottom of the bull's eye (the 6-o'clock position) (Fig. 7). The sights will then appear black against the white of the target. The point of impact, however, will be the center of the bull's eye.

The Rear Sight may be adjusted for elevation and, if necessary, windage.

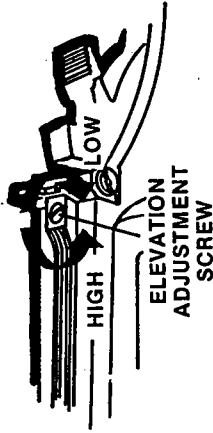

FIG. 8

Elevation

If the revolver is required to shoot higher the Rear Sight must be raised; to shoot lower the Rear Sight must be lowered. To raise the Rear Sight, be sure that the Hammer is set to the first notch position, then turn the Elevation Adjustment Screw counterclockwise (Fig. 8).

Test shoot the revolver to determine if the adjustment is sufficient. Repeat the procedure, with the Hammer set to the first notch position, if further adjustment is necessary.

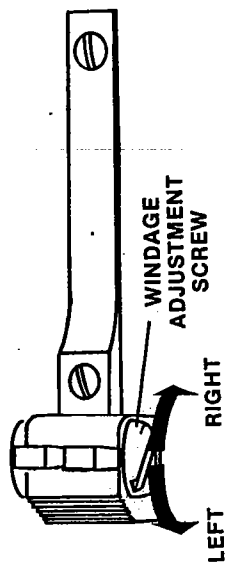

FIG. 9

Windage

If it is necessary to make an adjustment to compensate for windage, the Rear Sight must be moved in the same direction that you want to shoot. To make the revolver shoot more to the right, insure that the Hammer is set to the first notch position and turn the Windage Adjustment Screw on the right side of the gun clockwise (Fig. 9).

To lower the Rear Sight, be sure that the Hammer is set to the first notch position and turn the Elevation Adjustment Screw clockwise. Test shoot the revolver to determine if the adjustment is sufficient (Fig. 8). Repeat this part of the procedure, with the Hammer set to the first notch position, if further adjustment is necessary.

Test shoot the revolver to determine if the adjustment is sufficient. Repeat the procedure, with the Hammer set to the first notch position, if further adjustment to the right is necessary.

To make the revolver shoot more to the left, insure that the Hammer is set to the first notch position and turn the Windage

Adjustment Screw on the right side of the gun counterclockwise one click position at a time.

Test shoot the revolver to determine if the adjustment is sufficient. Repeat the procedure, with the Hammer set to the first notch position, if further adjustment to the left is necessary.

CARE OF THE 38

Treat your revolver with the same fine care that you would give your other valued possessions and it will give you a life time of service, pleasure and enjoyment. Be sure the Hammer is set to the first notch position and the revolver is unloaded when not in use. Always keep your revolver clean. Insure that dirt and grit do not enter the Barrel, Cylinder, or other moving parts. Gently wipe metal parts with a cloth moistened with Crosman PELLGUNOIL® to prevent rust and to preserve the finish.

For greatest accuracy, long barrel life and trouble-free performance, use only Crosman cal. .22 SUPER PELLETS®. The design and materials of other ammunition could cause loading failures, plugged barrel and permanent damage to your revolver. DO NOT expose charged revolver or POWERLETS® to excessive heat.

Lubrication

Be sure to follow these simple instructions to insure the long life of your revolver. To maintain trouble-free performance and eliminate most sealing failures, after every 250 shots or when moving parts appear dry, apply 2 or 3 drops of PELLGUNOIL® (Fig. 10). Apply 2 drops of PELLGUNOIL® to the piercing pin and external seal in the Piercing Assembly every 250 shots when the POWERLET® is replaced. Be sure the O-ring on the Piercing Assembly is clean and free of foreign matter which could cause excessive wear or damage.

pellgunoil®

FIG. 10

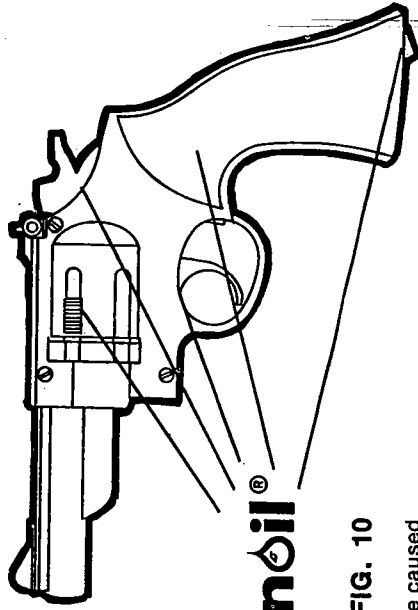

DO NOT over oil as harm may be caused to the gun action. DO NOT use penetrating, detergent, or regular gun oils as damage may be caused to the valve washers, seals and finish.

It is not necessary to clean the Barrel bore, but the occasional application of a little PELLGUNOIL® is recommended to prevent the Barrel from rusting.

WARNING: The use of any other lubricating oil other than Pellgunoil could result in damage to this gun.

CROSMAN AMMUNITION IS GUARANTEED FOR BEST SHOOTING RESULTS, LONGER GUN LIFE.



CROSMAN SUPER PELLETS®

- Best for any .177 caliber gun
- Lubricated, provided from 100% soft, virgin lead.
- No shattering
- Minimum ricochet
- Greater Safety
- Flat head and hollow skirt flatten on impact.
- Top accuracy
- Specialty designed skirt fits .177-CALIBER barrel
- Factory Sealed in self-dispenser boxes of 250 .22 and .177 Caliber

REPAIR SERVICE

It is recommended that, if repairs to your revolver become necessary, the work be entrusted to your nearest Crosman Authorized Service Station. Fully equipped and manned by specially trained staff, the world-wide network of Service Stations has been established to provide fast, efficient, local service in areas where no repair service is available. Repair Manual may be obtained for \$1.50 from Crosman Arms Company, 980 Turnpike Hill Road, Fairport, New York 14450, U.S.A.

CAUTION

The following suggestions are intended to serve as a useful reminder.

- DON'T** forget to treat every gun as if it is loaded.
- DON'T** alter or adjust any of the factory setting to your revolver.
- DON'T** forget to set the Hammer to the first notch position before loading.
- DON'T** re-use ammunition that has already been fired.
- DON'T** attempt to clear a Pellet jammed in the Barrel by shooting it out with another Pellet.
- DON'T** shoot steel darts as the accuracy of your revolver may be impaired or personal injuries may result.
- DON'T** point the revolver in an unsafe direction.
- DON'T** point the revolver at anything you do not intend to shoot.
- DON'T** shoot at the target until you are sure of your backstop.
- DON'T** shoot your revolver when the POWERLET® is low in gas pressure.
- DON'T** expose charged revolver or POWERLETS to excessive heat or cold.
- DON'T** over lubricate your revolver.
- DON'T** store your revolver loaded.
- DON'T** use your revolver without due respect for yourself or other people.
- DON'T** conduct yourself in an unsportsman-like manner when using your revolver.

IMPORTANT: Read Warranty and fill out Guarantee Certificate below at time of purchase.

WARRANTY

We guarantee this product for (90) days from date of purchase against defective materials and workmanship (providing the gun has not been abused).

EXCLUSION

To the extent all or any part of the following exclusion is prohibited by the law of any state or municipality, including the states of Kansas and California, shall not be applicable.

This is the only warranty expressed or implied and there is no warranty of merchantability nor fitness for a particular purpose. Consequently, incidental damages are excluded.

To qualify for warranty, certificate must be forwarded to the warranty station. Do not return product to factory without written permission.

WARRANTY CERTIFICATE

IMPORTANT: Keep this certificate. Cut and take to Crossman Authorized Service Station to qualify for warranty

Customer Name
Street
City State
Model
Dealer's Name
Date Purchased

PLACE
Necessary
Postage
HERE

CROSSMAN ARMS COMPANY
980 TURK HILL ROAD
FAIRPORT, NEW YORK 14450

CROSSMAN ARMS CO.
980 TURK HILL RD., FAIRPORT, N.Y. 14450
A DIVISION OF THE COLEMAN CO., INC.

Cut on Dotted Line