

454

**Crosman**  
Pellet/BB Guns  
**OWNER'S  
MANUAL**

**Model 454  
Semi-automatic  
CO2 BB Pistol**

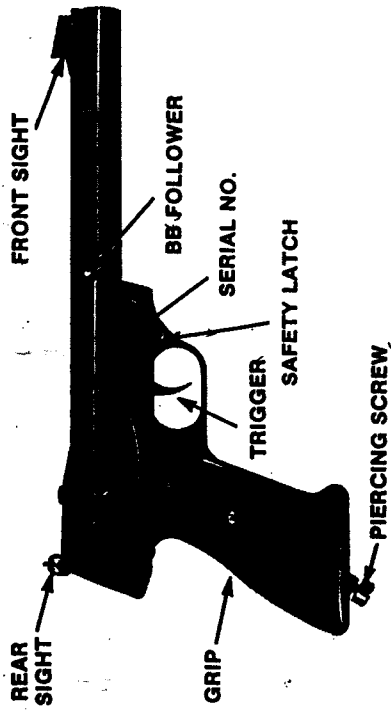

**Division**

**BE CAREFUL-BE A SAFESHOOTER**

**CAUTION: THIS AIR GUN IS NOT A TOY AND MAY CAUSE DEATH OR SERIOUS INJURY, PARTICULARLY TO THE EYE, IF MISUSED OR USED CARELESSLY. READ ALL INSTRUCTIONS BEFORE USING. THIS AIR GUN REQUIRES ADULT SUPERVISION IF THE USER IS**

**UNDER 16 YEARS OLD AND SHOULD NOT BE USED BY ANYONE UNDER 8 YEARS OF AGE. PURCHASER AND USER HAVE THE RESPONSIBILITY TO conform TO ALL LAWS CONCERNING THE USE AND OWNERSHIP OF THIS AIR GUN.**

**BE CAREFUL-BE A SAFESHOOTER**

#### **SPECIFICATIONS**

Mechanism Semi-automatic BB Repeater  
Caliber .177 BB  
Ammunition Crosman Super BBs®  
Magazine Capacity 16 BBs, force feed  
Weight 1 lb. 13 oz. (.85 kg)  
Overall Length 11 in. (279mm)  
Sights: Rear Fully adjustable for elevation and windage  
Front Ramped Blade  
Barrel 7¼ in. (197mm) steel tube, smooth bore  
Power Source One Crosman 12 gr. CO2 Powerlet®  
Grips Contoured with thumb rest for left or right hand shooters.

#### **PERFORMANCE**

(Average)  
Muzzle Velocity Above 325 f.p.s.  
Average 80 Shots per Powerlet at 70 ° F  
Projectile Weight .177 BB 5.42 gr.

**NOTE: Operating gun at below 70°F will decrease the number of effective shots, the reverse is true for gun operation above 70°F.**

#### **HOW TO OPERATE**

**IMPORTANT: Steps for safe and satisfactory operation.**

- Step 1 Put Pistol "ON SAFE"**
- Step 2 Remove factory installed CO2 Powerlet**
- Step 3 Load and Pierce CO2 Powerlet**
- Step 4 Load BBs**
- Step 5 Aim and Fire**

**BE CAREFUL-BE A SAFESHOOTER**

### Step 1 HOW TO PUT PISTOL ON "SAFE"

Pull the Safety Latch on the right side of the Trigger Guard to the rear to set the pistol "ON SAFE". (Fig. 1.)

FIG. 1

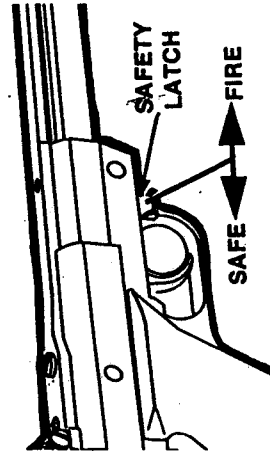

**CAUTION:** For your protection keep the pistol on "Safe" at all times until you are ready to shoot, then put safety in "Fire" position.

### Step 2 REMOVE THE FACTORY INSTALLED CO2 POWERLET.

Your new gun has an empty CO2 Powerlet in it which must be removed. It was used to test the gun at the factory.

Holding gun firmly by grip with one hand, slowly loosen Powerlet Piercing Screw all the way. Remove Grip with Powerlet attached. (See Figs. 2 and 3)

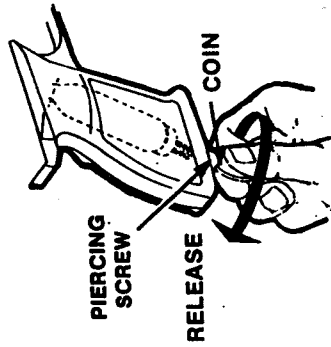

FIG. 2

**CAUTION:** Do not allow exhausted CO2 gas to come in contact with the skin, as it can cause frostbite.

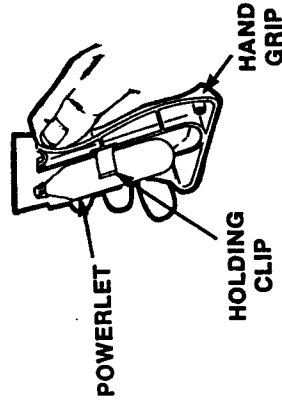

FIG. 3

### Step 3 HOW TO LOAD AND PIERCE CO2 POWERLET

A. Insert new Powerlet, small neck towards Piercing Assembly. See Fig. 4.

B. Holding Powerlet firmly with thumb of one hand, insert a coin (quarter) in

the slot of the Piercing Screw, turn in a clockwise direction until Powerlet is secure. (Fig. 4) This action pierces the Powerlet.

C. Replace Grip Cover.

D. Point in SAFE DIRECTION. Put pistol "OFF SAFE" and fire to see if Powerlet has been pierced. If pistol does not fire, repeat Step 3, Section B. Pull Trigger and fire again.

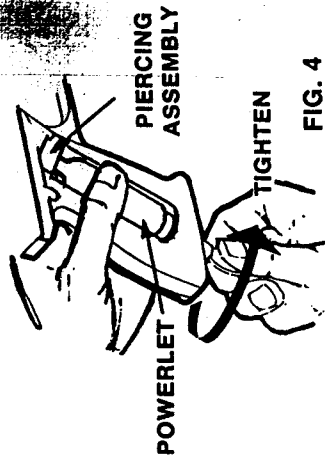

FIG. 4

#### Step 4 HOW TO LOAD BBS

Put gun "ON SAFE". Push the BB Follower Stem forward and down (Fig. 5) to locate it in the Holding Slot. With muzzle pointing slightly upward, load 16 Crosman Super BBs into Loading Port. When the Magazine is full, release the BB Follower from its Holding Slot.

To unload BBs from Magazine.

- Put gun "ON SAFE".
- Move BB Follower forward and engage in Holding Slot.
- Turn gun upside down, point gun muzzle slightly downward. Shake gun back and forth, BBs will drop out of BB Loading Port.

**CAUTION: Do not use Pellets in this gun...it will jam.**

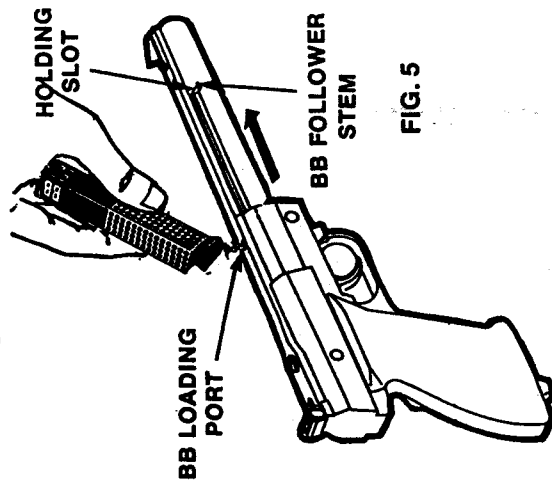

#### Step 5 HOW TO AIM AND FIRE

Point the pistol in a SAFE DIRECTION and when you are sure of your target and backstop, take pistol "OFF SAFE", take aim and squeeze the Trigger to fire.

**How to remove a jammed BB**

- Put gun "ON SAFE"
- Remove Powerlet (See step 2)
- Move BB Follower to Holding slot and remove BBs from Magazine (See Step 4).
- Take gun "OFF SAFE", pull and hold Trigger in rear position

E. Insert a metal rod or metal clothes hanger into Muzzle and gently push jammed BB back into Magazine.

F. Release Trigger, turn gun upside down, point gun Muzzle slightly downward, shake gun back and forth until BB drops out of Loading Port.

**IMPORTANT:** If unable to unjam your gun see REPAIR SERVICE section of manual.

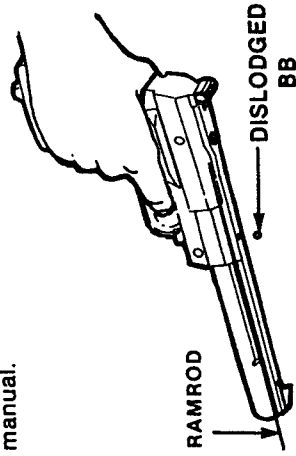

**BE CAREFUL-BE A SAFESHOOTER**

### HOW TO SIGHT IN THE 454

The pistol is correctly aimed when the blade of the Front Sight is positioned exactly in the notch of the Rear Sight, and the top of the Front Sight is flush with the top of the Rear Sight. For target shooting, many marksmen prefer to sight-in at the bottom of the bull's eye (the six o'clock position). The sights will then appear black against the white of the target. The point of impact, however, will be the center of the bull's eye (Fig. 6).

The Rear Sight may be adjusted for Elevation, and if necessary Windage (Fig. 7).

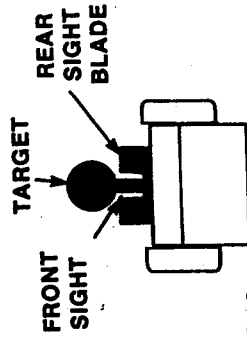

FIG. 6

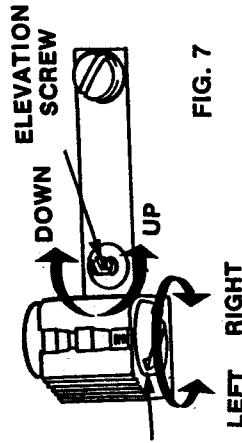

FIG. 7

## CAUTION

You must do the following things to insure safe and satisfactory performance of your gun.

- DON'T** forget to treat every gun as if it were loaded. It might be.
- DON'T** point the pistol in an unsafe direction.
- DON'T** use your pistol without due respect for yourself or other people.
- DON'T** shoot at the target until you are sure of your backstop.
- DON'T** conduct yourself in an unsportsmanlike manner when using your pistol.
- DON'T** store your pistol loaded.
- DON'T** shoot your pistol when the powderlet is low in gas pressure. It will jam your gun.
- DON'T** re-use ammunition that has already been fired. It will jam your gun.
- DON'T** attempt to clear a BB jammed in the Barrel by shooting it out with another BB.
- DON'T** use any ammunition other than Crosman SUPER BBs.
- DON'T** expose gun or POWER-LETS to excessive heat, (140° F.) It may explode.
- DON'T** alter or adjust any of the factory settings to your pistol, except the Rear Sight.

BE CAREFUL-BE A SAFESHOOTER

BE CAREFUL-BE A SAFESHOOTER

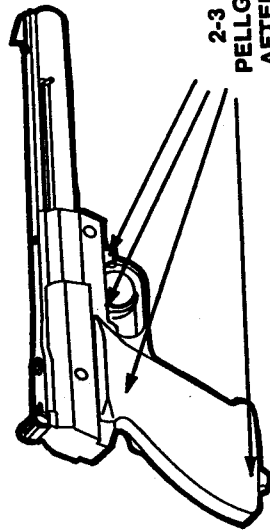

FIG. 8

2-3 DROPS OF  
PELLGUNOIL®HERE  
AFTER 250 SHOTS

#### LUBRICATION

Follow these simple instructions to insure the long life of your pistol. After every 250 shots apply 2 or 3 drops of Crosman PELLGUNOIL. (Fig. 8).

It is not necessary to clean the Barrel Bore, but the occasional application of a

little PELLGUNOIL is recommended to prevent the Barrel from rusting. Crosman PELLGUNOIL is recommended, but any household oil is better than no oil at all. This is very important.